

KSR Magnetic Float Switches

1003-4

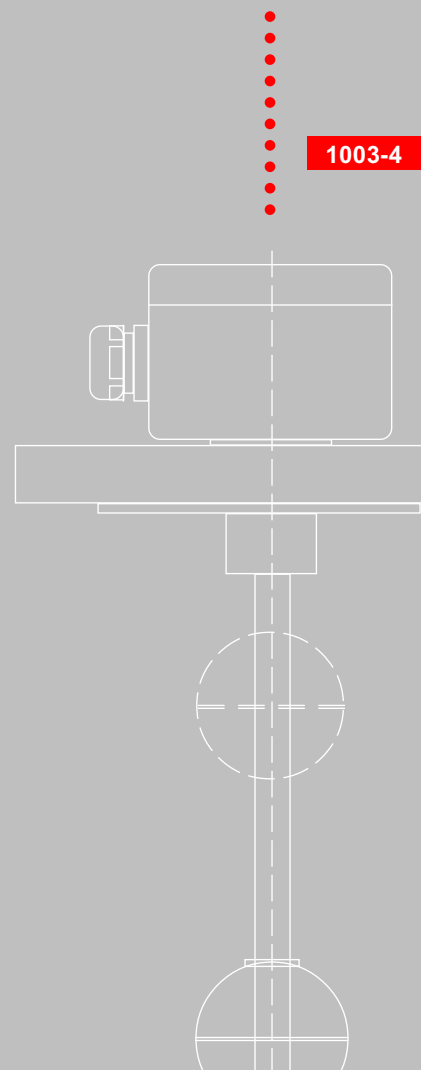



KSR KUEBLER Niveau-Messtechnik AG



69439 Zwingenberg
Germany
Tel ++49 (0) 62 63 - 87- 0
Fax ++49 (0) 62 63 - 87 99

info@ksr-kuebler.com
www.ksr-kuebler.com



KUBLER FRANCE S.A.
68700 Cernay

KSR KUEBLER (UK)
Level Measurement & Control Ltd.
Molesey, Surrey KT8 1QZ

KSR KUEBLER (SCANDINAVIA)
2970 Hørsholm

KSR KUEBLER (ITALY)
Misura di Livello
24030 Brembate S.(BG)

KSR KUEBLER (USA)
Level Control Products of America Inc.
Clarksville, VA 23927

KSR KUEBLER (SINGAPORE)
Level Measurement & Control Pte. Ltd.
Singapore 609916

SHANGHAI KSR KUEBLER
Automation Instruments Co. Ltd.
Shanghai / China

1003-4

Approvals



**Technischer Überwachungsverein
Südwestdeutschland e.V.**
Materials and type approval.
Approved for pressure vessels acc. to
AD-Merkblatt HP 0



**IBExU Institut für Sicherheitstechnik
GmbH**

IBExU

**Physikalisch Technische
Bundesanstalt PTB**



**Bundesamt für Wehrtechnik
und Beschaffung**

BWB

Germanischer Lloyd

Netherlands



KEMA

France

KEMA
REGISTERED QUALITY

**Laboratoire Central des Industries
Electriques**

LCIE

Bureau Veritas

Norway



Det Norske Veritas

Czech Republic



**Osvědčení o Nevýbušnosti
FTZÚ Ostrava Radvanice**



Slovakia



**Osvědčení o Nevýbušnosti
EVPÚ Nová Dubnica**

Russia



**Gosgortekhnadzor
OGS Oil & Gas Safety**



USA

Factory Mutual Research Corporation



Underwriters' Laboratories, Inc.

Canada



Canadian Standards Association

Contents

KSR Magnetic Float Switches

Description 4

Applications 5

Compass, Product range 6

Type code 7

KSR Magnetic Float Switches

Stainless steel SS 316 Ti 8

Stainless steel - adjustable 9



Stainless steel, II 1G EEx ia IIC T3-T6 10/11

Stainless steel, float Buna 12/13

Magnetic mini float switches 14/15

Food industry design 16

Sanitary design 17

Angular design 18/19

PVC, Polypropylene, or PVDF 20-23

Stainless steel, ECTFE-coated 24/25

Special flange design 26

Suspended float design 27

KSR Bypass Float Switches

Aluminium or Bronze 28

Stainless steel 29

Spherical floats 30

Cylindrical floats 31

Connection diagrams 32/33

Contact protection measures 34

KSR Magnetic Float Switches

KSR Magnetic Float Switches are used to control distinct levels of a liquid. They are based on the float principle with individual contacts for every level to be monitored.

A float with a built-in magnetic system actuates a small reed contact through the wall of the guide tube. Thus the switching operation is without direct contact to the liquid, free of wear and tear, and does not require any power supply.

KSR Magnetic Float Switches are available with multiple switch points.

- Contact denomination always refers to rising level of the liquid:
 - S - closing on rising level
 - O - opening on rising level
 - U - change-over
- By using one float up to a maximum of 2 switch points the switching behaviour is bistable i.e. the switching state will remain the same even when the liquid moves further up or down.
- Contacts are volt-free.

Technical advantages

- The simple operating principle is suitable for a wide variety of applications.
- Suitable for virtually all liquids.
- Measurement of liquid levels independent of physical or chemical changes of the liquid, e.g. foam, conductivity, dielectric constant, S.G., pressure, vacuum, temperature, vapour, condensation, bubbles, boiling effects.
- Universal signal processing
 - PLC
 - Initiator circuit (NAMUR)
 - Signal amplifiers/Protection relays
 - 2-point controls
- AS-Interface available, Ex/non-Ex.
- Multiple switch points in one unit (up to 8).
- High repeatability of set points.
- Long service life.
- Suitable for rough environments.
- Interface and product level measurement possible at Δ -S.G. $\geq 50 \text{ kg / m}^3$.
- Simple installation and commissioning, maintenance-free.
- Application limits:
 - T = $-196 \text{ }^\circ\text{C}$ to $+300 \text{ }^\circ\text{C}$
 - P = vacuum to 10 MPa
 - S.G. $\geq 400 \text{ kg/m}^3$
- High availability of corrosion resistant materials for applications in all industries:
 - Chemical, petrochemical, and pharmaceutical industry, liquid natural gas, off-shore, ship-building, power plants, manufacturing industry, water treatment, food and beverages.
- Application specific designs available.
- Explosion-proof designs.

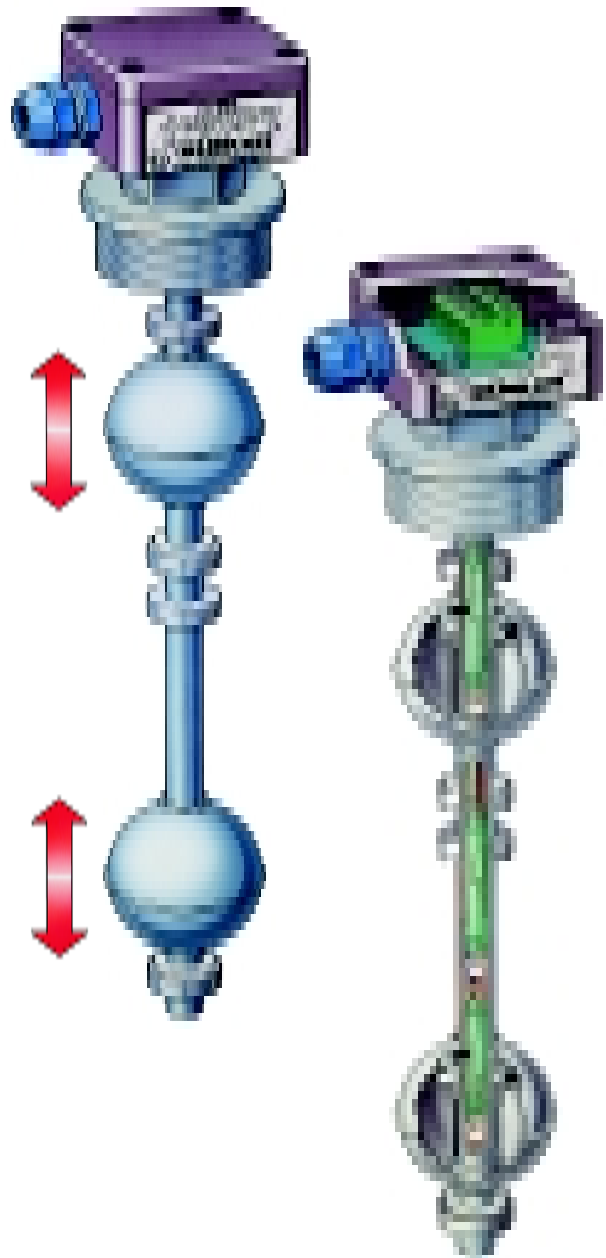

- Float switches are simple devices without certification according EN 50020/5.4.

As such, they are allowed to be used in Ex-area 'Zone 1', on condition, that they work with a certified intrinsically safe circuit in protection class EEx ib or higher.

Applications

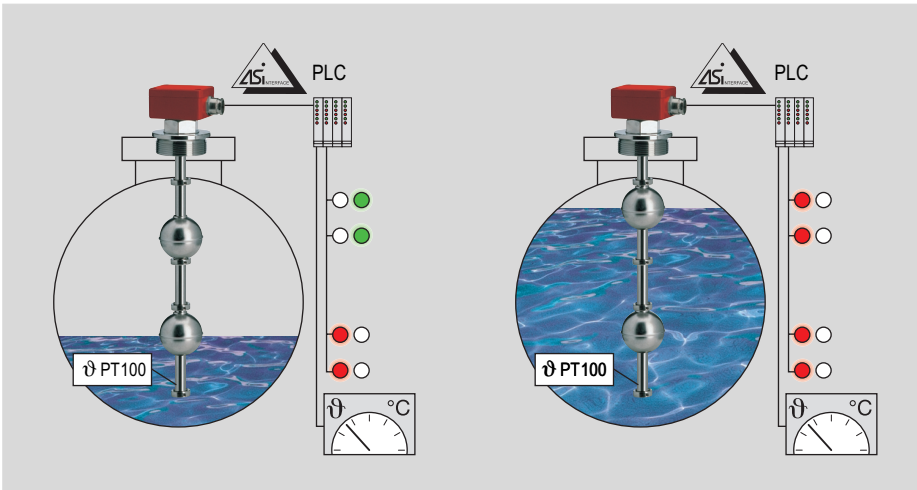

KSR Magnetic Float Switches with multiple switch points

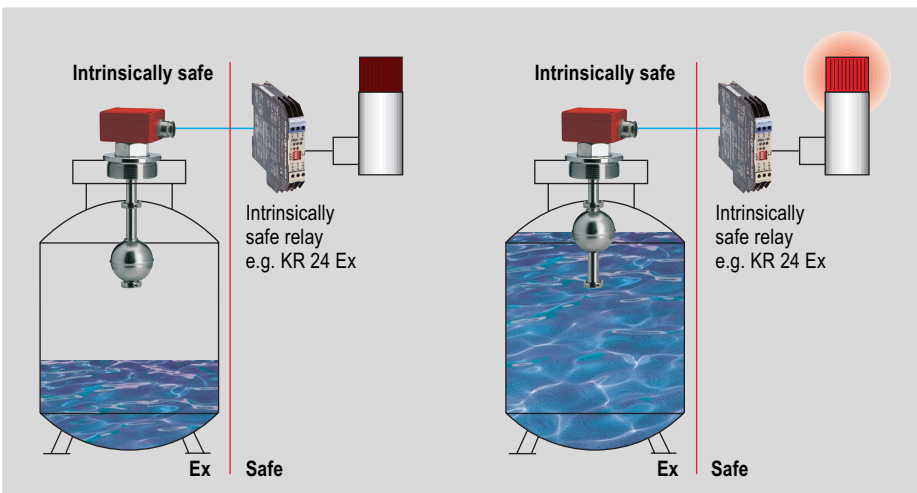

KSR Magnetic Float Switches for high alarm (EEx i)

1003-4

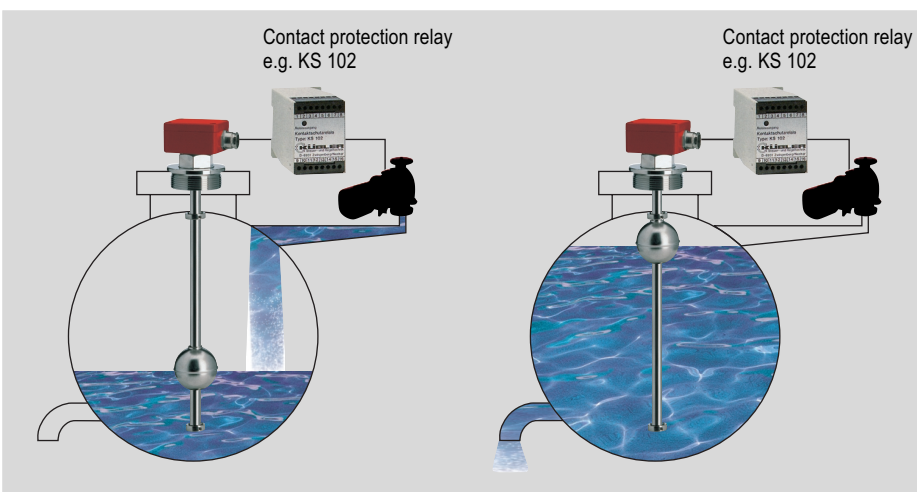

KSR Magnetic Float Switches for 2-point control (min/max.)

Compass

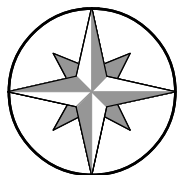

This page is intended to guide you through the product range of KSR KUEBLER for Magnetic Float Switches.

Please select connecting option and material and turn to the page referred to in the following table.

Material

Process	Stainless steel SS 316 Ti (1.4571)	Stainless steel SS 316 Ti (1.4571) 	PVC PP PVDF	Aluminium Bronze
<p>Thread BSP 1/8" BSP 3/8" BSP 1/2" BSP 1"</p>	<p>Page 8/12 9 adjustable 14 mini 17 sanitary</p>		<p>Page 20/21/22</p>	
<p>Thread BSP 3/4" BSP 1" BSP 1 1/2" BSP 2"</p>	<p>Page 8/12 9 adjustable 14 mini</p>	<p>Page 10</p>	<p>Page 20/21/22</p>	
<p>Flange DN...PN..</p>	<p>Page 8/12 9 adjustable 24 coated</p>	<p>Page 10</p>	<p>Page 20/21/22</p>	
<p>Angular design</p>	<p>Page 18</p>		<p>Page 19</p>	
<p>Bypass- Float Switches</p>	<p>Page 29</p>			<p>Page 28</p>

1003-4

Type Code

Code	1st key	2nd key	3rd key
1	Electrical connection	Process connection	Material process connection
-	(none) - connection cable	ER Mounting thread upwards (BSP)	V Stainless steel SS 316 Ti
A	Terminal box Aluminium	R Mounting thread downwards (BSP)	VE Stainless steel polished
AB	Terminal box Polypropylene	ENPT Mounting thread upwards (NPT)	VEC Stainless steel ECTFE-coated
AP	Terminal box Polyester	NPT Mounting thread downwards (NPT)	VTF Stainless steel PTFE-lined
AVT	Terminal box, with screw cap	MR Dairy fitting acc. to DIN 11851	T Titanium
	Stainless steel SS 316 Ti	F Flange (DIN, ANSI, JIS)	HB Hastelloy B
AD	Terminal box, flameproof	FC Clamp-connection acc. to DIN 32676	HC Hastelloy C
	Aluminium	IS Sanitary nozzle (Ingoldstutzen)	P PVC
ASC4	Coupler plug C 164-232-F-4P		PP Polypropylene
ASC5	Coupler plug C 164-332-F-5P		PF PVDF
ASC7	Coupler plug C 164-4337-F-7P		M Brass flange OD 74 mm
ASH	Coupler plug Harting HAN 7 D		K Oval flange, Polyamide
ASQ	Coupler plug QUICKON max.4-pin		
2	Size process connection		
...	Mounting thread size in inches		
...	Threaded connection size DN 50 - DN 150		
.../	Flange nominal size	.../	Flange pressure rating
DIN	DN 50 - DN 200	PN 6 - PN 100	...
ANSI	2"- 8"	Class 150 - 600	Flange face
JIS	2"(DN 50) - 8"(DN 200)	5 K- 63 K	Standard Form C optional E,A,F,N
Clamp	DN 25 - DN 100; 1"- 4"		Standard RF optional RTJ,FF,ST,SG
3	Guide tube material	Contact separation	Optional code adder
...	V Stainless steel SS 316 Ti	S Closing	HT.. High temperature +150°C...+300°C
	VE Stainless steel electropolished	O Opening	TT.. Low temperature -30°C...-196°C
	VEC Stainless steel ECTFE-coated	U Change over	H Increased hysteresis
	VTF Stainless steel PTFE-lined		PT100 Temperature probe PT 100 (2,-3- or 4-core)
	HB Hastelloy B		..TH.. Temperature switch ...°C - closing or opening
	HC Hastelloy C		R... Current limitation using resistor .. Ohm
	P PVC		N acc. to NAMUR DIN EN 60947-5-6
	PP Polypropylene		
	PF PVDF		
	W... Angular design (V,P,PP)		
4	Guide tube length	OD Guide tube	
L.../...	L.../ length in mm	... OD in mm	
5	Float design see page 30/31		
.../...	.../ Material (code 3, 1st key)	... Float OD in mm	
6	Connection cable	Cable material	Optional adder
.../...	.../ length in Meter	- PVC grey	SL Earth connection
		blue PVC blue	
		SIL Silicone	
		ÖL Ölflex	

1003-4

Order example

Code	Connection design / material	Connection size	Guide tube material switch function	Guide tube length / OD	Float	Cable length / material
	1	2	3	4	5	6
	AFV	50/6/F	V S O U	L950/12	V44A	-

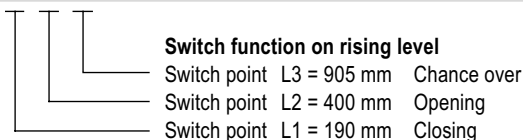

KSR Magnetic Float Switches



Stainless steel SS 316 Ti (1.4571)

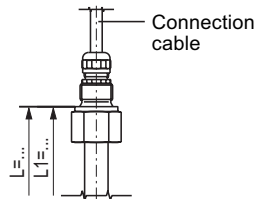

ERV...-V-L.../-V-A-1...

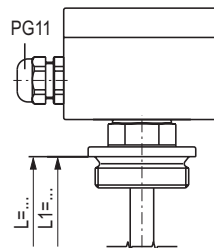

ARV...-V-L.../V...-A

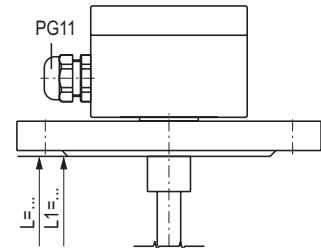

AFV.../-.../-V-L.../V...-A

Electrical connection	Cable PVC grey, PVC blue, Silicone, Ölflex		Terminal box Aluminium 64 x 58 x 34 mm, with 1 contact Aluminium 80 x 75 x 57 mm, 2 or more contacts Option Polypropylene, Polyester, Stainless steel	
Process connection	Mounting thread upwards BSP 3/8" BSP 1/2"		Mounting thread downwards BSP 1 1/2" or BSP 2"	Mounting flange DIN DN50-DN200, PN6-PN100 ANSI 2"-8", Class 150-600
Guide tube - OD	12 or 14 mm	18 mm	12 or 14 mm	18 mm
Guide tube length max.	3000 mm	6000 mm	3000 mm	6000 mm
Float	V44A, V52A, V62A, V83A V80A, V98A, V105A, V120A		guide tube - OD 12 or 14 mm guide tube - OD 18 mm	
Limit S.G. 85%	see KSR Floats page 30/31			
Limit S.G. 50%	see KSR Floats page 30/31			
Nominal pressure				
Temperature range standard	PVC / Ölflex cable -10°C... +80°C Silicone cable -30°C...+150°C	-30°C...+150°C		
High temperature			Optional code (HT..) +150°C...+300°C	see page 34
Low temperature			Optional code (TT..) -30°C...-196°C	
Switch function	optional closing S , opening O or change-over SPDT U - on rising level			
Number of contacts	PVC cable 6 x S or O , or 4 x U Silicone cable 3 x S or O , or 2 x U	6 x S or O , or 4 x U		
Switch rating	closing 230V AC; 100VA; 1A opening 230V AC; 100VA; 1A change-over 230V AC; 40VA; 1A	230V DC; 50W; 0.5A 230V DC; 50W; 0.5A 230V DC; 20W; 0.5A		
	Attention: Designs without earthing connection - use low voltage only e.g. contact protection relays (see catalogue 1011) or external protective earth			
Orientation	vertical ± 30°			
Ingress protection	IP 65			
	Materials 1.4435, 1.4539, Titanium, Hastelloy and others available upon request			

1003-4

KSR Magnetic Float Switches



Stainless steel SS 316 Ti (1.4571) - adjustable

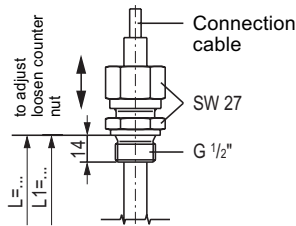

RV-1/2"-V-L.../12-V.A-1...-verst.

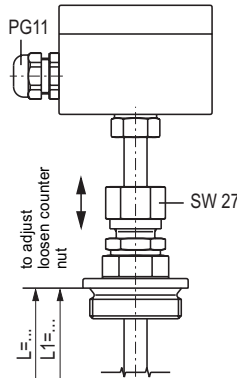

ARV-..."-V-L.../12-V.A-verst.

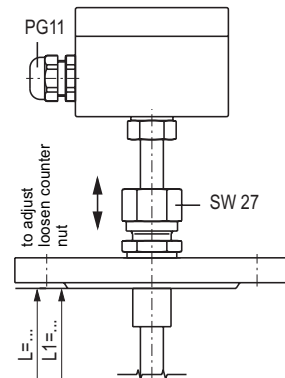

AFV-.../...-V-L.../12-V.A-verst.

Electrical connection	Cable PVC grey, PVC blue, Silicone, Ölflex	Terminal box Aluminium 64 x 58 x 34 mm, with 1 contact Aluminium 80 x 75 x 57 mm, 2 or more contacts Option Polypropylene, Polyester, Stainless steel
Process connection	Mounting thread downwards BSP 1/2"	Mounting thread downwards BSP 1 1/2" or BSP 2" Mounting flange DIN DN50-DN200, PN6-PN100 ANSI 2"-8", Class 150-600
Guide tube - OD	12 mm	
Guide tube length max.	3000 mm	
Float	V44A, V52A, V62A, V83A	
Limit S.G. 85%	see KSR Floats page 30/31	
Limit S.G. 50%		
Nominal pressure	0.5 MPa	
Temperature range	PVC- / Ölflex cable -10°C... +80°C Silicone cable -30°C...+150°C	-30°C...+150°C
Switch function	optional closing S , opening O or change-over SPDT U - on rising level	
Number of contacts	PVC cable 6 x S or O , or 4 x U Silicone cable 3 x S or O , or 2 x U	6 x S or O , or 4 x U
Switch rating	closing 230V AC; 100VA; 1A opening 230V AC; 100VA; 1A change-over 230V AC; 40VA; 1A	230V DC; 50W; 0.5A 230V DC; 50W; 0.5A 230V DC; 20W; 0.5A
	Attention: Designs without earthing connection - use low voltage only e.g. contact protection relays (see catalogue 1011) or external protective earth	
Orientation	vertical ± 30°	
Ingress protection	IP 54	IP 65
	Materials 1.4435, 1.4539, Titanium, Hastelloy and others available upon request	

1003-4

KSR Magnetic Float Switches



II 1G EEx ia IIC T3-T6 KEMA 01 ATEX 1053X Stainless steel SS 316 Ti (1.4571)

Process temperature	Raised terminal box
	X
< 60 °C	0 mm
< 135 °C	60 mm
< 180 °C	80 mm

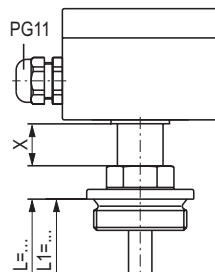

60-V-G...-V...-L.../-S...

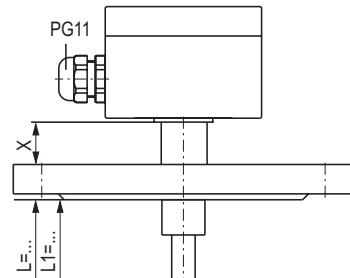

80-V-DN...PN...-V...-L.../-S...

Electrical connection	Terminal box Aluminium 80 x 75 x 57 mm, Option Polyester, Stainless steel	
Process connection	Mounting thread downwards BSP 1" - BSP 2"	Mounting flange DIN DN50 - DN150, PN6 - PN64 ANSI 2"-6", Class 150-600
Guide tube - OD	12 mm or 14 mm	
Guide tube length max.	3000 mm	
Float	SVK, SV, SVA, SVB, SVB23	
Limit S.G. 85%	see KSR Floats page 30/31	
Limit S.G. 50%	see KSR Floats page 30/31	
Nominal pressure	see KSR Floats page 30/31	
Temperature class	T3	T4
Process temperature	max. 180°C	130°C
Ambient temperature at terminal box	max. 60°C	60°C
	T5	T6
	95°C	80°C
	60°C	60°C
Switch function	optional closing S or opening O - on rising level	
Number of contacts	3 x S or O	
Switch rating	only for use in certified intrinsically safe circuits with U_{max} 36 V, I_{max} 100 mA	
Orientation	vertical $\pm 30^\circ$	
Ingress protection	IP 65	
	Materials 1.4435, Titanium and Hastelloy upon request	

1003-4

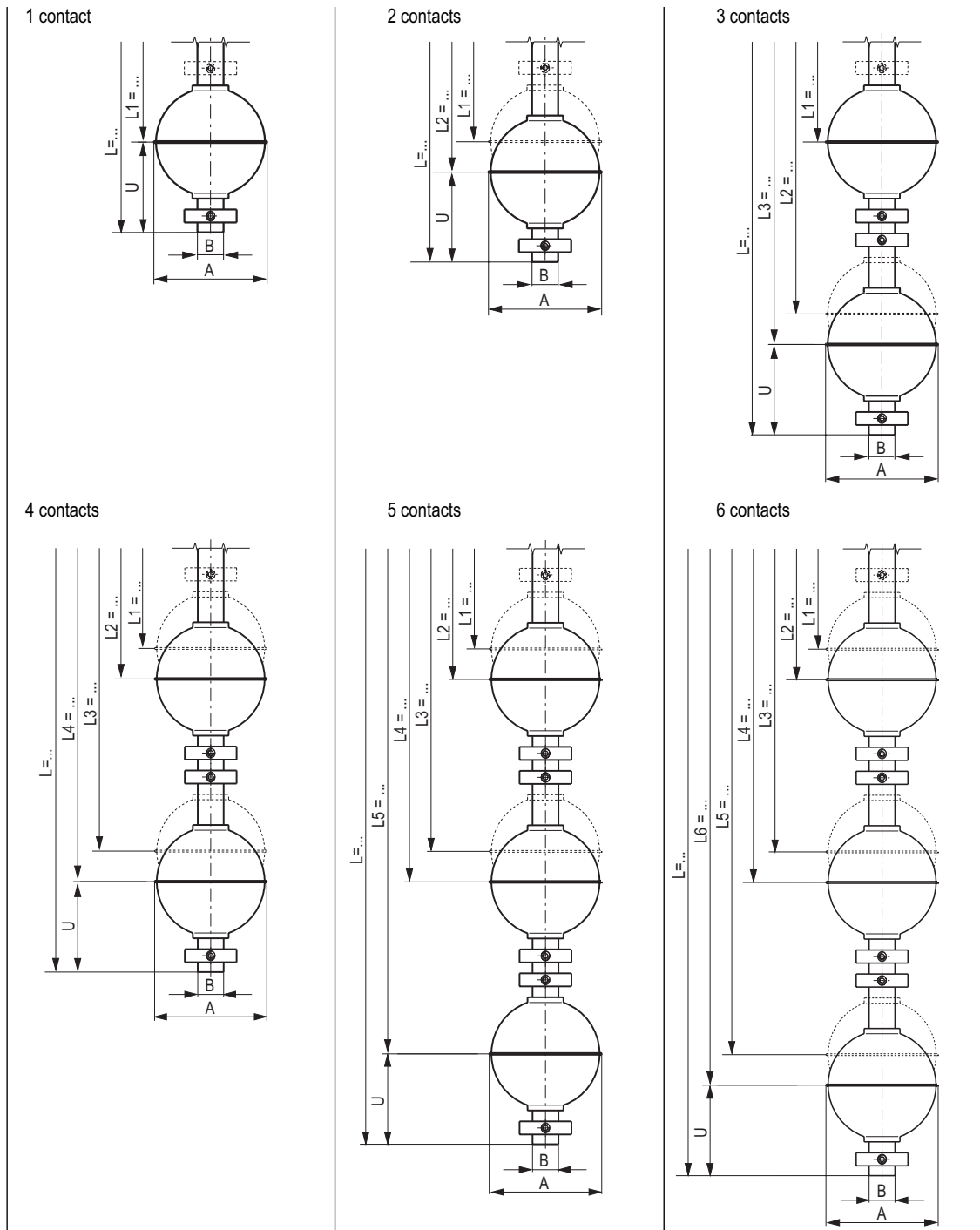

Float type	A mm	B mm	L1 min. mm	U min. mm	Distance between contacts	
					2 contacts 1 float mm	2 contacts 2 floats mm
V44A (SVK)	44	12 or 14	55	45	20	80
V52A (SV)	52	12 or 14	55	45	20	80
V62A (SVA)	62	12 or 14	60	50	20	90
V83A (SVB)	83	12 or 14	70	60	20	110
V80A (SVB23)	80	18	90	65	20	125
V98A	98	18	100	75	20	145
V105A	105	18	105	80	20	155
V120A	120	18	115	90	20	170

Connection diagrams page 32-33

KSR Magnetic Float Switches



Stainless steel SS 316 Ti (1.4571) - Buna float

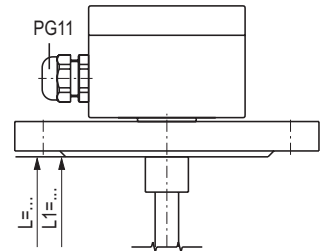
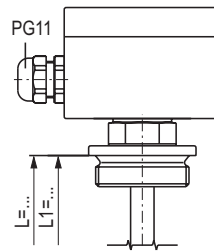
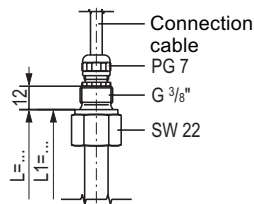

ERV- $\frac{3}{8}$ "-V-L.../-B..A-1...

ARV-..."-V-L.../-B..A

AFV-..."/.../-V-L.../-B..A

Electrical connection	Cable PVC grey, PVC blue, Silicone, Oilflex	Terminal box Aluminium, Polypropylene, Polyester, Stainless steel
Process connection	Mounting thread upwards BSP $\frac{3}{8}$ "	Mounting thread downwards BSP 1", BSP $1\frac{1}{2}$ " or BSP 2" Mounting flange DIN DN40-DN100, PN6-PN40 ANSI $1\frac{1}{2}$ "- 4", Class 150-300
Guide tube - OD	12 mm	
Guide tube length max.	3000 mm	
Float	B30A, B40A	
Limit S.G. 85%		
Limit S.G. 50%	see KSR Floats page 30/31	
Nominal pressure		
Temperature range	-10°C... +80°C	
Switch function	optional Closing S , Opening O or Change-over SPDT U - on rising level	
Number of contacts	PVC cable 6 x S or O , or 4 x U Silicone cable 3 x S or O , or 2 x U	6 x S or O , or 4 x U
Switch rating	closing 230V AC; 100VA; 1A opening 230V AC; 100VA; 1A change-over 230V AC; 40VA; 1A	230V DC; 50W; 0.5A 230V DC; 50W; 0.5A 230V DC; 20W; 0.5A
	Attention: Designs without earthing connection - use low voltage only e.g. contact protection relays (see catalogue 1011) or external protective earth	
Orientation	vertical $\pm 30^\circ$	
Ingress protection	IP 65	

1003-4

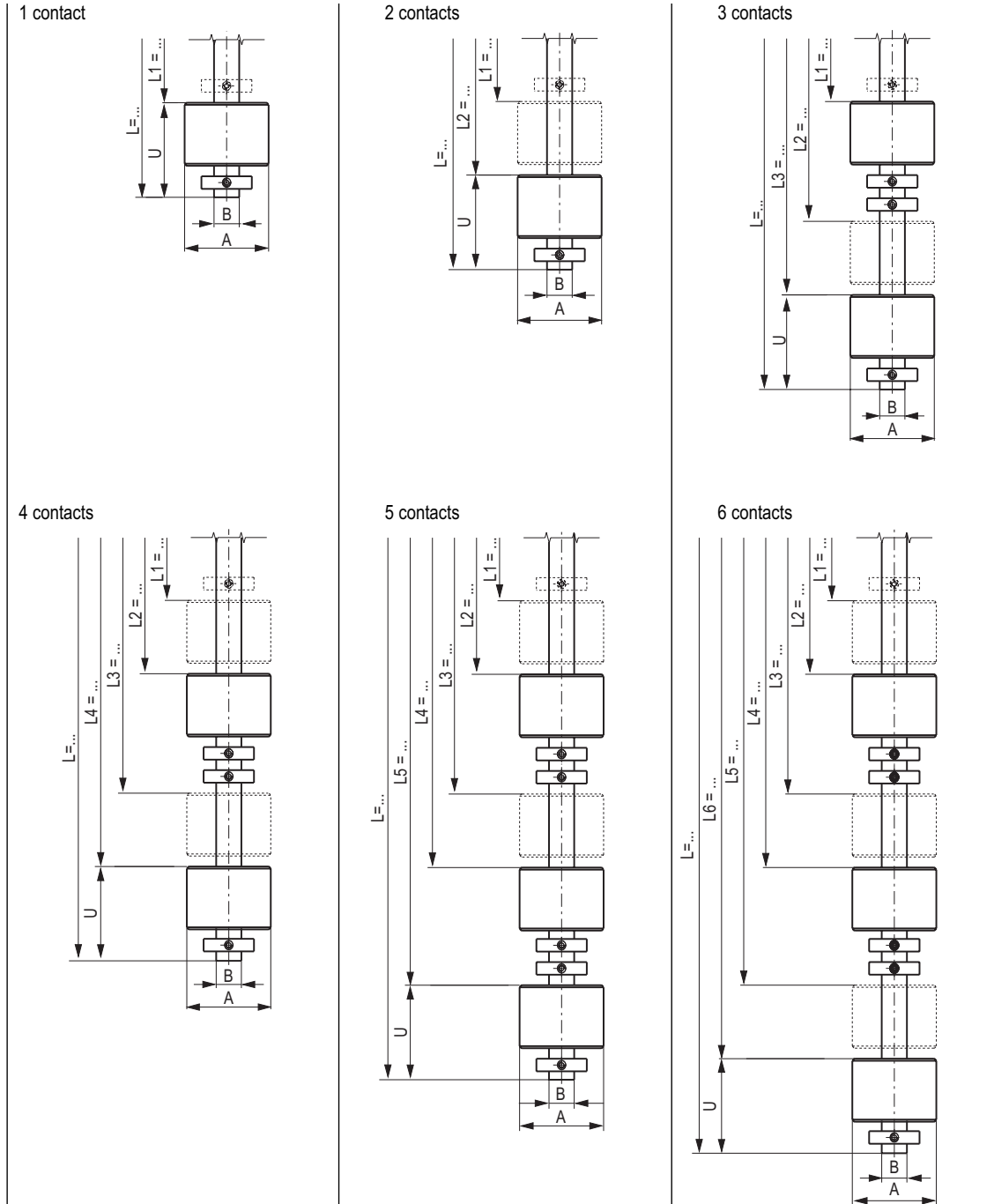

1003-4

Float type	A mm	B mm	L1 min. mm	U min. mm	Distance between contacts	
					2 contacts 1 float mm	2 contacts 2 floats mm
B30A	30	12	40	65	20	75
B40A	40	12	40	45	20	65

Connection diagrams page 32-33

Connection diagrams page 32-33

KSR Magnetic Float Switches



Stainless steel SS 316 Ti (1.4571)

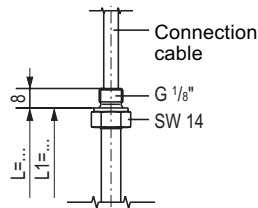

ERV-1/8"-V-L.../8-B-A-1...

Terminal box **A**

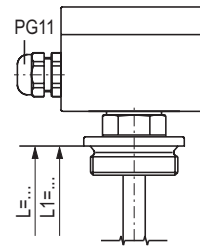

ERV-1/8"-V-L.../8-PP27A-1...

Coupler plug **ASC4**

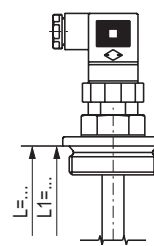

Coupler plug **ASC5**
Coupler plug **ASC7**

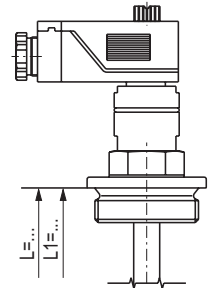

ERV-1/8"-V-L.../8-V29A/-1...

Electrical connection	Cable	PVC grey, PVC blue, Silicone, Ölflex		
	Optional	Terminal box	A Aluminium 64 x 58 x 34 mm	
		Coupler plug	ASC4 C 164-232-F-4P	
		Coupler plug	ASC5 C 164-332-F-5P	
		Coupler plug	ASC7 C 164-4337-F-7P	
Process connection		Mounting thread upwards BSP 1/8"		
	Option	Mounting thread downwards BSP 3/4" or BSP 1"		
Guide tube - OD		8 mm		
Guide tube length max.		500 mm		
Float	Buna	Polypropylene	Stainless steel	
	B23A, B25A	PP27A	V29A/0,15 or V29A/0,2	
Limit S.G. 85%	see KSR Floats page 30/31			
Limit S.G. 50%	see KSR Floats page 30/31			
Nominal pressure	see KSR Floats page 30/31			
Temperature range	-10°C... +60°C		-10°C... +80°C	
Switch function	optional closing S , opening O or change-over SPDT U - on rising level			
Number of contacts	3 x S or O , or 1 x U			
Switch rating	closing	250V AC; 10VA; 0.5A	250V DC; 5W; 0.25A	
	opening	250V AC; 10VA; 0.5A	250V DC; 5W; 0.25A	
	change-over	28V AC; 6VA; 0.6A	28V DC; 3W; 0.3A	
	Attention: Designs without earthing connection - use low voltage only e.g. contact protection relays (see catalogue 1011) or external protective earth			
Orientation	vertical ± 30°			
Ingress protection	IP 54	with optional terminal box or connecting plug IP 65		

1003-4

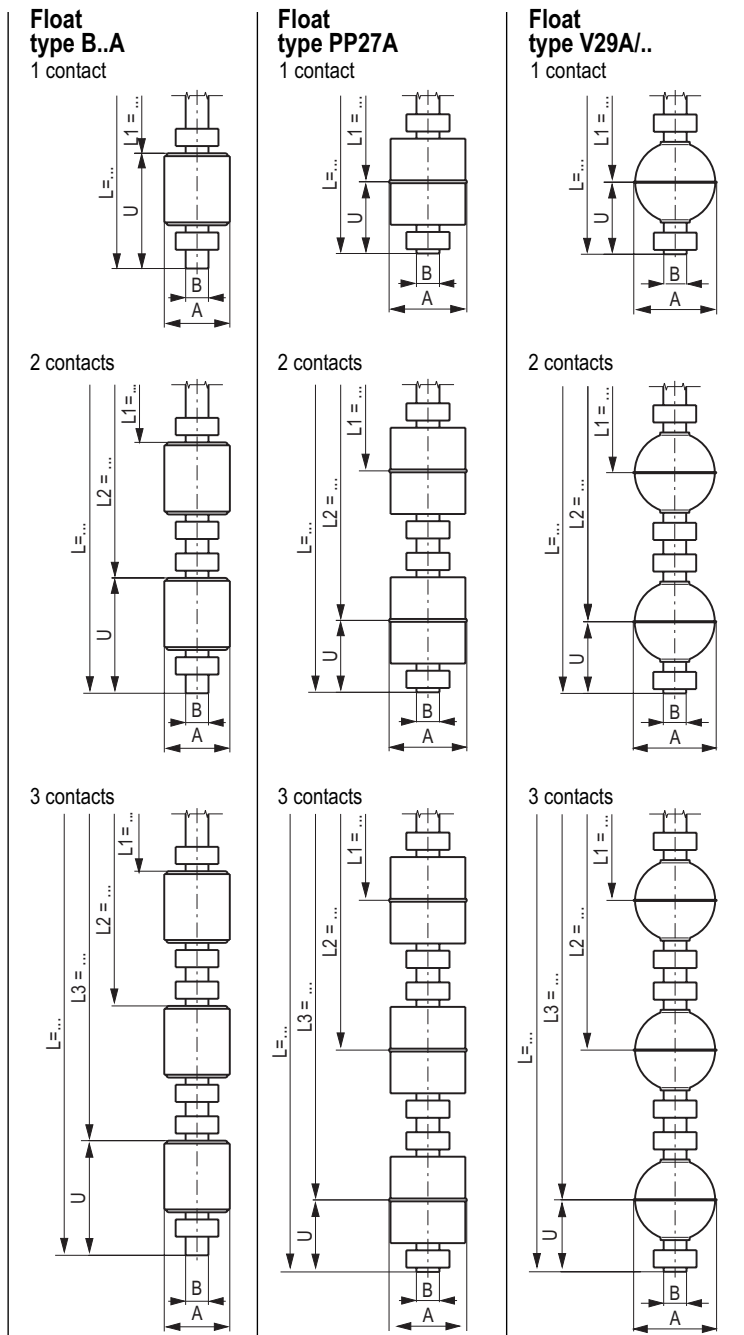

Connection diagrams

Colour coding to IEC 757

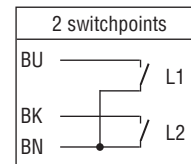
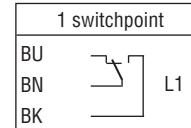
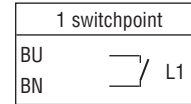

PVC cable

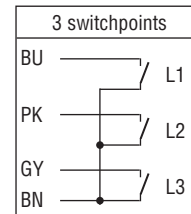

Silicone cable

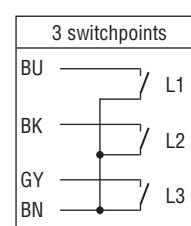

Float type	A mm	B mm	L1 min. mm	U min. mm	Distance between contacts
					2 contacts 2 floats mm
B23A	23	8	15	40	45
B25A	25	8	15	25	35
PP27A	27	8	35	25	50
V29A/0.15	29	8	35	25	50
V29A/0.2	29	8	35	25	50

Food industry design - Stainless steel SS 316 L

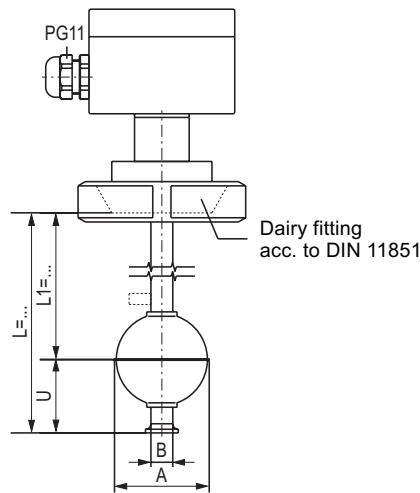

AMRV...-VE-L.../-VE.A

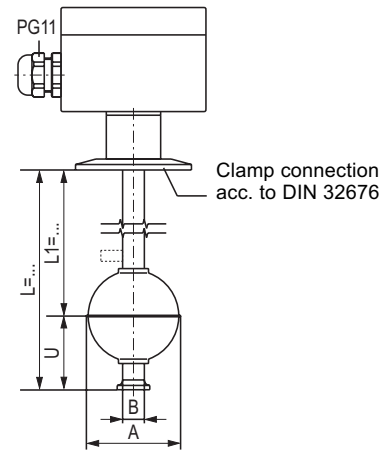

AFCV...-VE-L.../-VE.A

Electrical connection	Terminal box Aluminium 64 x 58 x 34 mm, with 1 contact Aluminium 80 x 75 x 57 mm, 2 or more contacts Option Polypropylene, Polyester, Stainless steel	
Process connection	Dairy fitting acc. to DIN 11851 DN50 - DN150	Clamp-connection acc. to DIN 32676 DN25 - DN100 or 1" - 4"
Guide tube - OD	12 mm, 14 mm or 18 mm	
Guide tube length max.	3000 mm guide tube OD 12 mm and 14 mm, 6000 mm guide tube OD 18 mm	
Float	VE44A, VE52A, VE62A, VE83A, VE80A, VE98A, VE105A, VE120A,	guide tube OD 12 mm and 14 mm guide tube OD 18 mm
Limit S.G. 85% Limit S.G. 50% Nominal pressure	see KSR Floats page 30/31	
Temperature range standard	-30°C...+150°C	
High temperature (HT..)	+150°C...+300°C see page 34	
Switch function	optional closing S , opening O or change-over SPDT U - on rising level	
Number of contacts	6 x S or O , or 4 x U	
Switch rating	closing 230V AC; 100VA; 1A 230V DC; 50W; 0.5A opening 230V AC; 100VA; 1A 230V DC; 50W; 0.5A change-over 230V AC; 40VA; 1A 230V DC; 20W; 0.5A	
	Attention: Designs without earthing connection - use low voltage only e.g. contact protection relays (see catalogue 1011) or external protective earth	
Orientation	vertical ± 30°	
Ingress protection	IP 65	

Float type	A mm	B mm	L1 min. mm	U min. mm	Distance between contacts	
					2 contacts 1 float mm	2 contacts 2 floats mm
VE44A	44	12 or 14	55	45	20	80
VE52A	52	12 or 14	55	45	20	80
VE62A	62	12 or 14	60	50	20	90
VE83A	83	12 or 14	70	60	20	110
VE80A	80	18	90	65	20	125
VE98A	98	18	100	75	20	145
VE105A	105	18	105	80	20	155
VE120A	120	18	115	90	20	170

Connection diagrams page 32-33

Sanitary design - Stainless steel SS 316 L

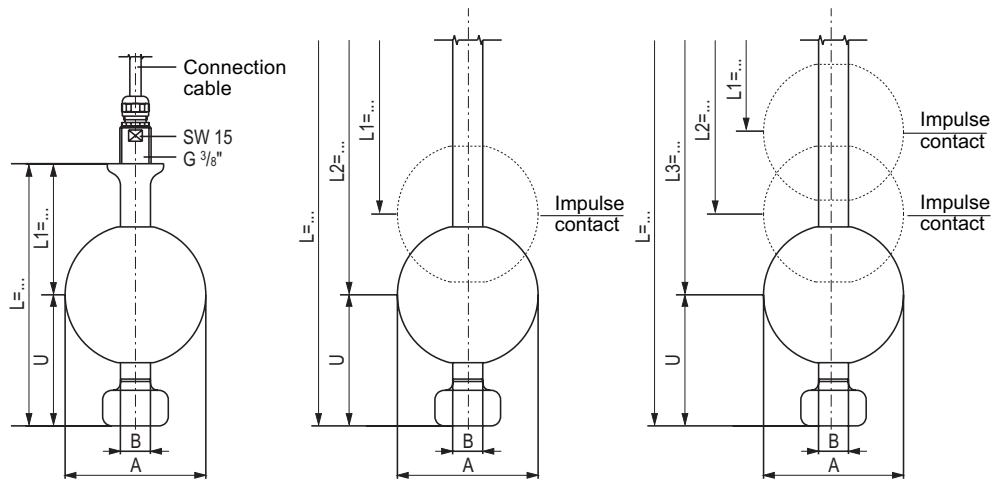

ERV-3/8"-V-L.../17-V80A/3A/-1...

Electrical connection	Cable	PVC grey, PVC blue, Silicone, Ölflex
	Option	Terminal box
Process connection	Mounting thread upwards	BSP 3/8"
	Option	Mounting flange acc. to DIN or ANSI Dairy fitting acc. to DIN 11851 Clamp connection acc. to DIN 32676 Sanitary nozzle (Ingoldstutzen)
Guide tube - OD	17,2 mm	Stainless steel SS 316 L (1.4435) or 1.4539 - ground and polished
Guide tube length max.	5000 mm	
Float	V80A/3A/...	Stainless steel SS 316 L (1.4435) or 1.4539 - ground and polished
Limit S.G. 85%	715 kg/m ³	
Limit S.G. 50%	1220 kg/m ³	
Nominal pressure	2.5 MPa	
Temperature range	PVC and Ölflex cable -10°C ... +80°C, Silicone cable -30°C ... +150°C	
Switch function	optional closing S , opening O or change-over SPDT U - on rising level	
Number of contacts	PVC cable 6 x S or O , or 4 x U , Silicone cable 3 x S or O , or 2 x U	
Switch rating	closing	230V AC; 100VA; 1A 230V DC; 50W; 0.5A
	opening	230V AC; 100VA; 1A 230V DC; 50W; 0.5A
	change-over	230V AC; 40VA; 1A 230V DC; 20W; 0.5A
	Attention: Designs without earthing connection - use low voltage only e.g. contact protection relays (see catalogue 1011) or external protective earth	
Orientation	vertical ± 30°	
Ingress protection	IP 65	

Float type	A	B	L1	U	Distance between contacts
	mm	mm	min. mm	min. mm	2 contacts mm
V80A/3A	80	17,2	90	85	50

Connection diagrams page 32-33

KSR Magnetic Float Switch



Angular design - Stainless steel SS 316 Ti (1.4571)

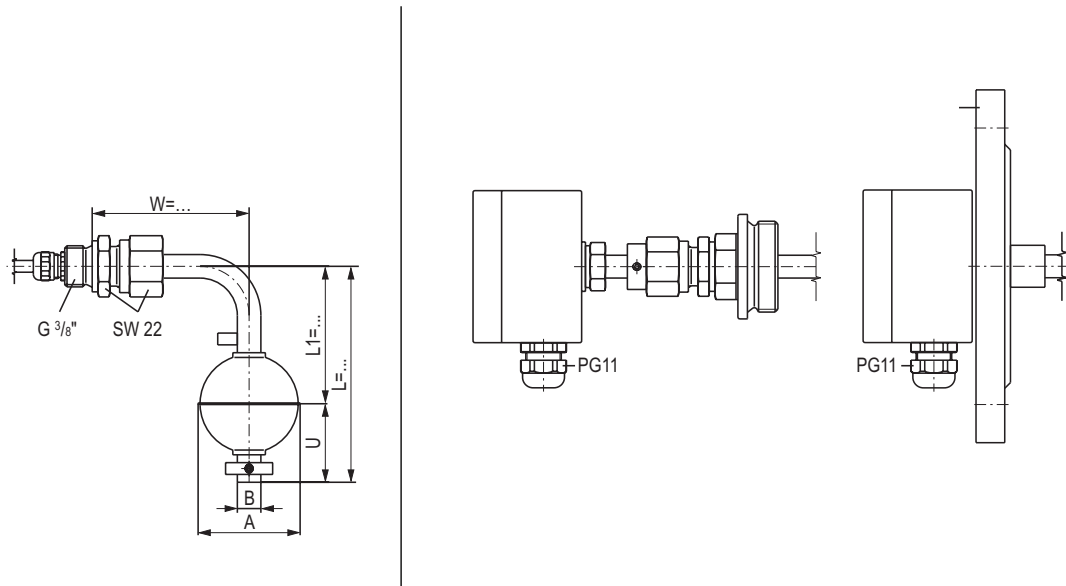

ERV-3/8"-W..V..L.../12-V..A-1...

Electrical connection	Cable	PVC grey, PVC blue, Silicone, Ölflex
	Option	Terminal box
Process connection	Mounting thread	BSP 3/8"
	Option	Mounting thread BSP 1 1/2" or BSP 2" Mounting flange acc. to DIN or ANSI
Guide tube - OD		12 mm
Guide tube length max.		3000 mm
Float		V44A, V52A, V62A, V83A
Limit S.G. 85%		see KSR Floats page 30/31
Limit S.G. 50%		
Nominal pressure		
Temperature range		PVC and Ölflex cable -10°C ... +80°C, Silicone cable -30°C ... +150°C
Switch function		optional closing S , opening O or change-over SPDT U - on rising level
Number of contacts		PVC cable 6 x S or O , or 4 x U , Silicone cable 3 x S or O , or 2 x U
Switch rating	closing	230V AC; 100VA; 1A 230V DC: 50W; 0.5A
	opening	230V AC; 100VA; 1A 230V DC: 50W; 0.5A
	change-over	230V AC; 40VA; 1A 230V DC: 20W; 0.5A
		Attention: Designs without earthing connection - use low voltage only e.g. contact protection relays (see catalogue 1011) or external protective earth
Orientation		vertical ± 30°
Ingress protection		IP 65

Float type	A mm	B mm	L1 min. mm	U min. mm	W min. mm	Distance between contacts	
						2 contacts 1 float mm	2 contacts 2 floats mm
V44A	44	12 or 14	75	45	80	20	80
V52A	52	12 or 14	75	45	80	20	80
V62A	62	12 or 14	80	50	80	20	90
V83A	83	12 or 14	90	60	80	20	110

Connection diagrams page 32-33

1003-4

KSR Magnetic Float Switches



Angular design - PVC or Polypropylene

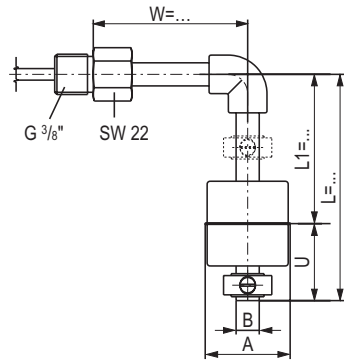

ERP- $\frac{3}{8}$ "-W..P.-L.../12-P44A-1...

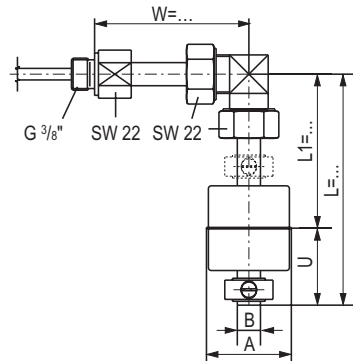

ERPP- $\frac{3}{8}$ "-W..PP.-L.../12-PP44A-1...

Electrical connection	Cable PVC grey, PVC blue, Silicone, Öflex	
Process connection	Mounting thread BSP $\frac{3}{8}$ "	
Guide tube - OD	12 mm	
Guide tube length max.	1000 mm	
Float	P44A	PP44A
Limit S.G. 85% Limit S.G. 50% Nominal pressure	see KSR Floats page 30/31	
Temperature range	0°C ... +60°C	-10°C ... +80°C
Switch function	optional closing S , opening O or change-over SPDT U - on rising level	
Number of contacts	4 x S or O or 3 x U	
Switch rating	closing 230V AC; 100VA; 1A opening 230V AC; 100VA; 1A change-over 230V AC; 40VA; 1A	230V DC; 50W; 0.5A 230V DC; 50W; 0.5A 230V DC; 20W; 0.5A
Orientation	vertical $\pm 30^\circ$	
Ingress protection	IP 54	

1003-4

Float type	A mm	B mm	L1 min. mm	U min. mm	W min. mm	Distance between contacts	
						2 contacts 1 float mm	2 contacts 2 floats mm
P44A	44	12	80	40	70	50	80
PP44A	44	12	80	40	70	50	80

Connection diagrams page 32-33

KSR Magnetic Float Switches



PVC, Polypropylene, PVDF

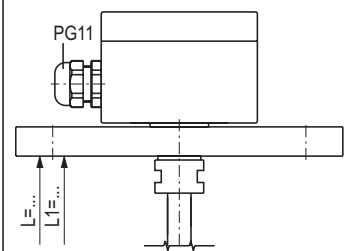
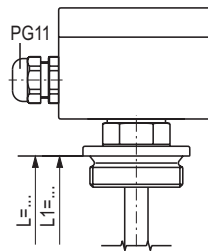
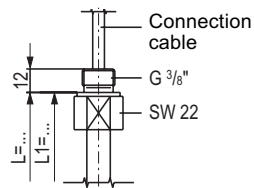

PVC	ERP-3/8"-P-L.../12-P44A-1...	ABRP-..."-P-L.../12-P44A	ABFP-.../10-P-L.../12-P44A
Polypropylene	ERPP-3/8"-PP-L.../12-PP44A-1...	ABRPP-..."-PP-L.../12-PP44A	ABFPP-.../10-PP-L.../12-PP44A
PVDF	ERP-3/8"-PF-L.../12-PF44A-1...	ABRPF-..."-PF-L.../12-PF44A	ABFPP-.../10-PF-L.../12-PF44A
Electrical connection	Cable PVC grey, PVC blue Ölflex	Terminal box Polypropylene 80 x 82 x 55 mm	
Process connection	Mounting thread upwards BSP 3/8"	Mounting thread downwards BSP 1 1/2" or BSP 2"	Mounting flange DIN DN50 – DN100 PN10 Form A ANSI 2" - 4", Class 150 FF
Guide tube - OD	12 mm		
Guide tube length max.	500 mm		
Float	PVC P44A Polypropylene PP44A PVDF PF44A		
Limit S.G. 85% Limit S.G. 50% Nominal pressure	see KSR Floats page 30/31		
Temperature range	PVC 0°C ... +60°C Polypropylene -10°C ... +80°C PVDF -10°C ... +100°C		
Switch function	optional closing S , opening O or change-over SPDT U - on rising level		
Number of contacts	4 x S or O (PP max.3), or 3 x U (PP max.2)		
Switch rating	closing 230V AC; 100VA; 1A opening 230V AC; 100VA; 1A change-over 230V AC; 40VA; 1A	230V DC; 50W; 0.5A 230V DC; 50W; 0.5A 230V DC; 20W; 0.5A	
Orientation	vertical ± 30°		
Ingress protection	IP 54	IP 65	

1003-4

KSR Magnetic Float Switches



PVC, Polypropylene, PVDF

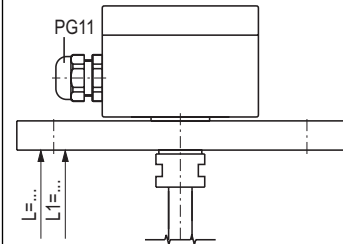
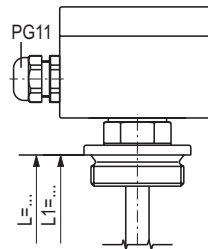
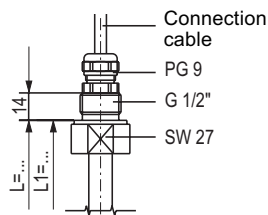

PVC	ERP-1/2"-P-L.../16-P55A-1...	APRP-2"-P-L.../16-P55A	APFP-.../10-P-L.../16-P55A
Polypropylene	ERPP-1/2"-PP-L.../16-PP55A-1...	APRPP-2"-PP-L.../16-PP55A	APFPP-.../10-PP-L.../16-PP55A
PVDF	ERPF-1/2"-PF-L.../16-PF55A-1...	APRPF-2"-PF-L.../16-PF55A	APFPF-.../10-PF-L.../16-PF55A
Electrical connection	Cable PVC grey, PVC blue Ölflex	Terminal box Polyester 80 x 75 x 55 mm	
Process connection	Mounting thread upwards BSP 1/2"	Mounting thread downwards BSP 2"	Mounting flange DIN DN65 – DN125 PN10 Form A ANSI 2 1/2" - 4", Class 150 FF
Guide tube - OD	16 mm, reinforced with metal insert		
Guide tube length max.	3000 mm		
Float	PVC P55A Polypropylene PP55A PVDF PF55A		
Limit S.G. 85% Limit S.G. 50% Nominal pressure	see KSR Floats page 30/31		
Temperature range	PVC 0°C ... +60°C Polypropylene -10°C ... +80°C PVDF -10°C ... +100°C		
Switch function	optional closing S , opening O or change-over SPDT U - on rising level		
Number of contacts	6 x S or O , or 4 x U		
Switch rating	closing 230V AC; 100VA; 1A opening 230V AC; 100VA; 1A change-over 230V AC; 40VA; 1A	230V DC; 50W; 0.5A 230V DC; 50W; 0.5A 230V DC; 20W; 0.5A	
Orientation	vertical ± 30°		
Ingress protection	IP 65		

1003-4

KSR Magnetic Float Switches



PVC, Polypropylene, PVDF

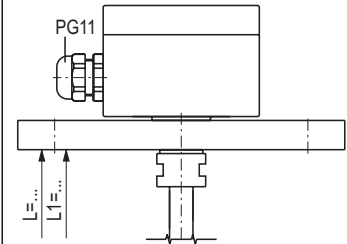
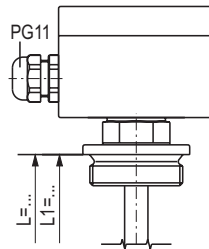
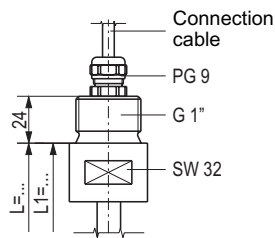

PVC	ERP-1"-P-L.../20-P.A-1...		APRP-2"-P-L.../20-P.A	APFP-.../10-P-L.../20-P.A
Polypropylene	ERPP-1"-PP-L.../20-PP.A-1...		APRPP-2"-PP-L.../20-PP.A	APFPP-.../10-PP-L.../20-PP.A
PVDF	ERPF-1"-PF-L.../20-PF.A-1...		APRPF-2"-PF-L.../20-PF.A	APFPF-.../10-PF-L.../20-PF.A
Electrical connection	Cable	PVC grey, PVC blue, Ölflex	Terminal box Polyester 80 x 75 x 55 mm	
Process connection	Mounting thread upwards BSP 1"		Mounting thread downwards BSP 2"	Mounting flange DIN DN65 – DN125 PN10 Form A ANSI 2 1/2" - 5", Class 150 FF
Guide tube - OD	20 mm, reinforced with metal insert			
Guide tube length max.	5000 mm			
Float	PVC	P55A/26 or P80A		
	Polypropylene	PP55A/26 or PP80A		
	PVDF	PF55A/26 or PF80A		
Limit S.G. 85%	see KSR Floats page 30/31			
Limit S.G. 50%	see KSR Floats page 30/31			
Nominal pressure	see KSR Floats page 30/31			
Temperature range	PVC	0°C ... +60°C		
	Polypropylene	-10°C ... +80°C		
	PVDF	-10°C ... +100°C		
Switch function	optional closing S , opening O or change-over SPDT U - on rising level			
Number of contacts	6 x S or O , or 4 x U			
Switch rating	closing	230V AC; 100VA; 1A	230V DC; 50W; 0.5A	
	opening	230V AC; 100VA; 1A	230V DC; 50W; 0.5A	
	change-over	230V AC; 40VA; 1A	230V DC; 20W; 0.5A	
Orientation	vertical ± 30°			
Ingress protection	IP 65			

1003-4

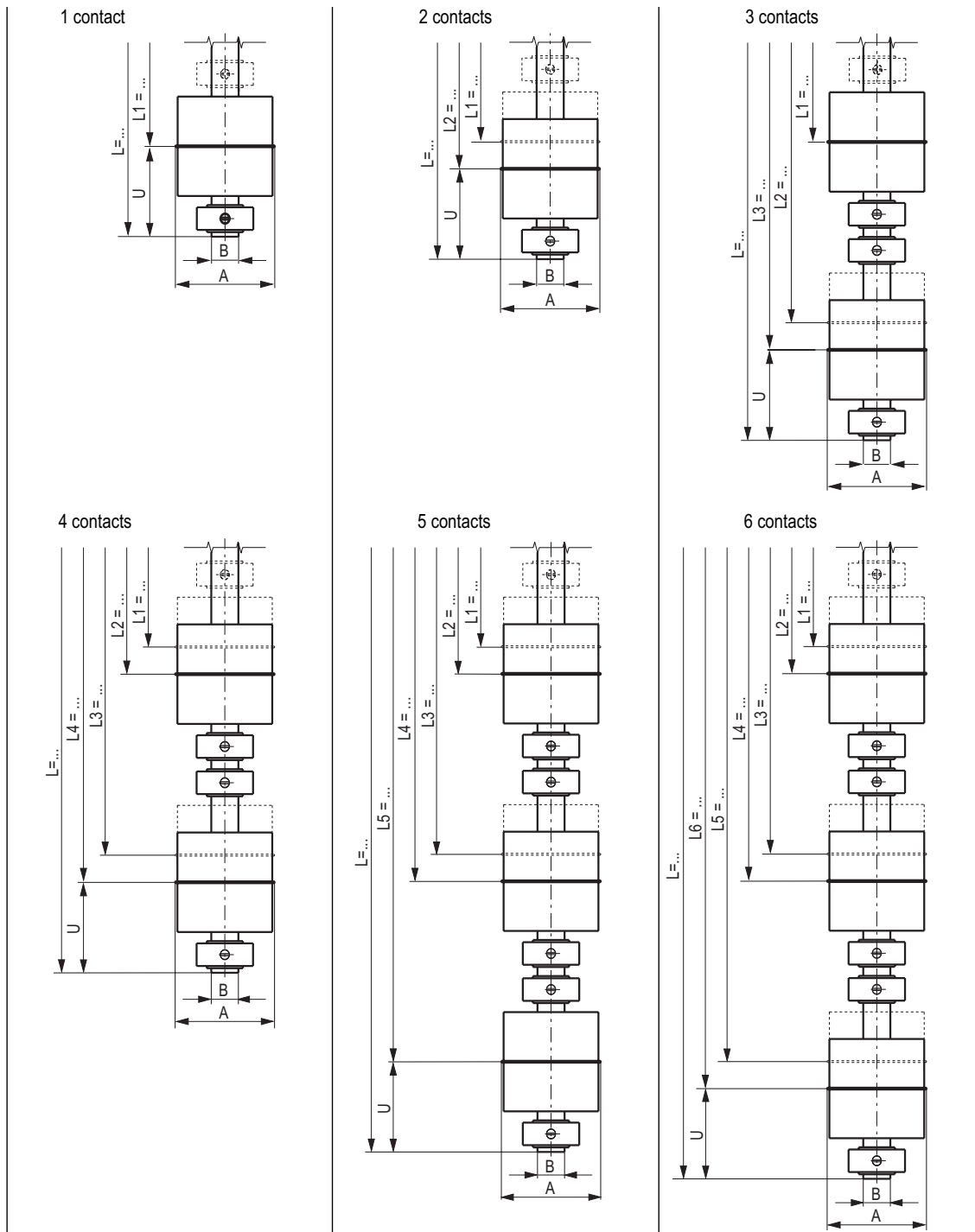

1003-4

Float type	A	B	L1 min.	U min.	Distance between contacts	
					2 contacts 1 float	2 contacts 2 floats
mm	mm	mm	mm	mm	mm	mm
P44A PP44A	44	12	50	40	50	80
PF44A	44	12	55	45	50	90
P55A PP55A PF55A	55	16	70	60	20	100
P55A/26 PP55A/26 PF55A/26	55	20	80	70	20	120
P80A PP80A PF80A	80	20	80	70	20	120

Connection diagrams page 32-33

KSR Magnetic Float Switches



Stainless steel SS 316 Ti (1.4571), ECTFE-coated Option: anti-static

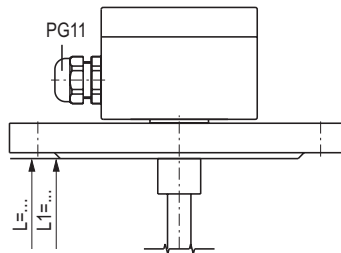

	AFVEC-.../.../-VEC-L.../12-VEC.A	AFVEC-.../.../-VEC-L.../18-VEC.A
Electrical connection	Terminal box Aluminium 64 x 58 x 34 mm, with 1 contact Aluminium 80 x 75 x 57 mm, 2 or more contacts Option Polypropylene, Polyester, Stainless steel	
Process connection	Mounting flange DIN DN50 - DN200 , PN6 – PN40, ANSI 2" - 8" , Class 150 - 300	
Guide tube - OD	12 mm	18 mm
Guide tube length max.	2000 mm	4000 mm
Float	VEC45A, VEC53A, VEC63A, VEC84A	VEC81A, VEC99A, VEC106A, VEC121A
Limit S.G. 85%	see KSR Floats page 30/31	
Limit S.G. 50%		
Nominal pressure		
Temperature range	depending on liquid	
Switch function	optional closing S , opening O or change-over SPDT U - on rising level	
Number of contacts	3 x S or O or 2 x U	6 x S or O or 4 x U
Switch rating	closing 230V AC; 100VA; 1A 230V DC; 50W; 0.5A opening 230V AC; 100VA; 1A 230V DC; 50W; 0.5A change-over 230V AC; 40VA; 1A 230V DC; 20W; 0.5A Attention: Designs without earthing connection - use low voltage only e.g. contact protection relays (see catalogue 1011) or external protective earth	
Orientation	vertical ± 30°	
Ingress protection	IP 65	

1003-4

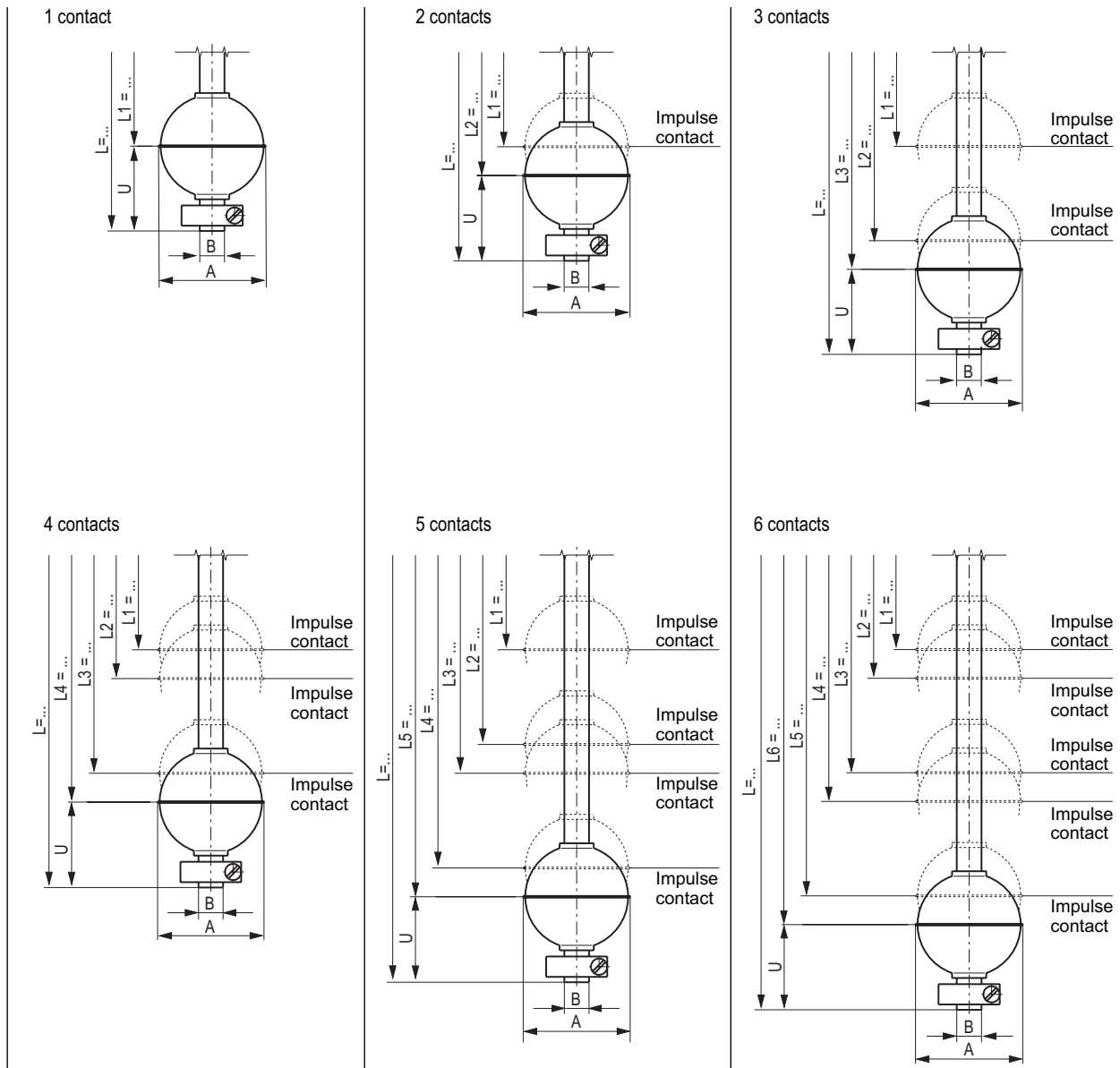

1003-4

Float type	A mm	B mm	L1 min. mm	U min. mm	Distance between contacts 2 contacts mm
VEC45A	45	12	55	55	50
VEC53A	53	12	55	55	50
VEC63A	63	12	60	60	50
VEC84A	84	12	70	70	50
VEC81A	81	18	90	75	50
VEC99A	99	18	100	85	50
VEC106A	106	18	105	90	50
VEC121A	121	18	115	100	50

Connection diagrams page 32-33

Special flange design - Stainless steel SS 316 Ti (1.4571)

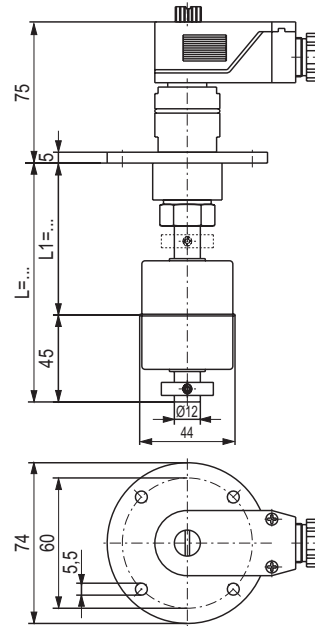
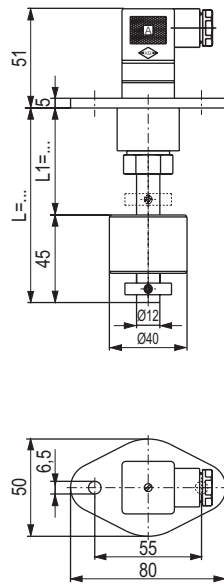

ASC4FPA-V-L.../12-B40A

ASC..FM-V.-L.../12-V44A

Electrical connection	Coupler plug C164-232F-4P	Coupler plug C164-332-F-5P C164-4337-F-7P
Process connection	Oval flange, Polyamide	Brass flange
Guide tube - OD	12 mm	
Guide tube length max.	3000 mm	
Float	B40A	V44A
Limit S.G. 85%	see KSR Floats page 30/31	
Limit S.G. 50%		
Nominal pressure		
Temperature range	0°C ... +60°C	-10°C...+80°C
Switch function	optional closing S , opening O or change-over SPDT U - on rising level	
Number of contacts	2 x S or O or 1 x U	3 x S or O or 2 x U
Switch rating	closing 230V AC; 100VA; 1A 230V DC; 50W; 0.5A opening 230V AC; 100VA; 1A 230V DC; 50W; 0.5A change-over 230V AC; 40VA; 1A 230V DC; 20W; 0.5A	
Orientation	vertical ± 30°	
Ingress protection	IP 65	

Connection diagrams page 32-33

1003-4

KSR Suspended Float Switches



Stainless steel SS 316 Ti (1.4571) - Buna float

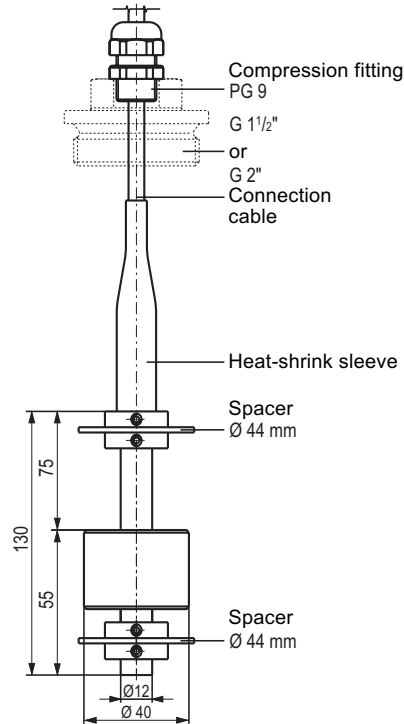

HV-L130-B40A-3ÖI

Electrical connection	Cable 3 m Ölflex
Process connection	Compression fitting PG 9, Option: mounting thread BSP 1 1/2" or BSP 2" Polypropylene
Guide tube - OD	12 mm
Guide tube length	130 mm
Float	B40A Option: V44A
Nominal pressure	atmospheric
Temperature range	-10°C ... +60°C
Switch function	optional closing S , opening O or change-over SPDT U - on rising level
Number of contacts	1
Switch rating	48V AC; 20VA; 0.4A 48V DC, 10W; 0.2A
Orientation	vertikal
Ingress protection	IP 68

Connection diagrams page 32-33

1003-4

KSR Bypass Float Switches



Chamber Aluminium or Bronze

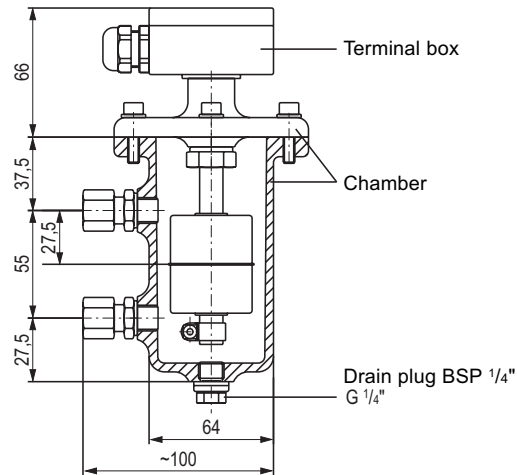

	ABAU	ABRU
Chamber	Aluminium AlMg5	Bronze Rg5
Nominal pressure (Chamber)	max. 0.1 MPa	max. 0.6 Mpa
Process connection	Compression fitting GE10-LR, brass	
Distance centre-to-centre	55 mm	
Electrical connection	Terminal box, Aluminium 64 x 58 x 34 mm	
Guide tube - OD	12 mm Stainless steel SS 316 Ti (1.4571)	
Float	V44A	
Limit S.G. 85%	see KSR Floats page 30/31	
Limit S.G. 50%	see KSR Floats page 30/31	
Temperature range	-30°C ... +150°C	
Switch function	1 change-over SPDT (U)	
Switch rating	230V AC, 40VA, 1A 230V DC, 20W, 0.5A	
Orientation	vertical ± 30°	
Ingress protection	IP 65	

1003-4

KSR Bypass Float Switches



Chamber Stainless steel SS 316 Ti (1.4571)

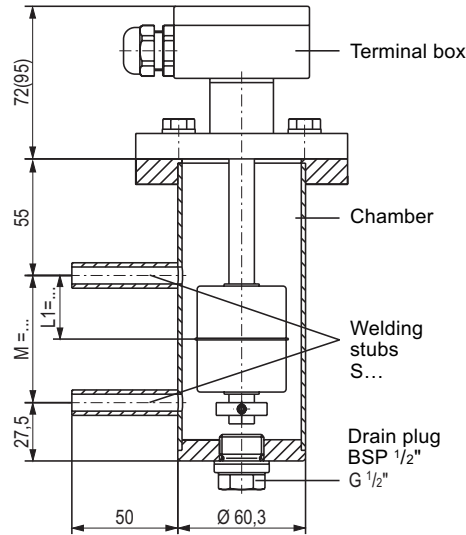

A-BV...-M...

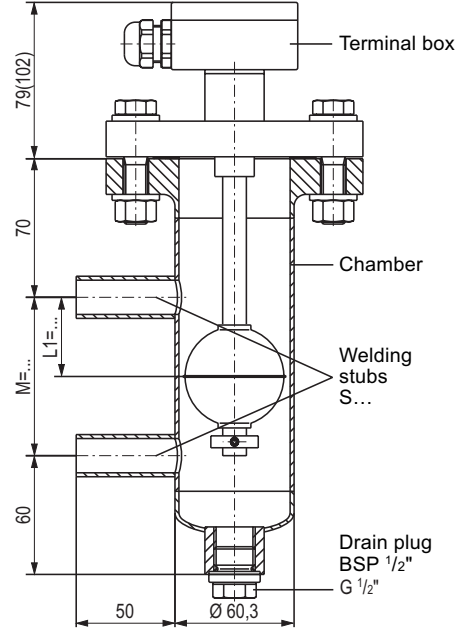

A-BV...-M...-TRB

acc. to TRB 801, No.45, Group A and B

Chamber	Stainless steel SS 316 Ti (1.4571)	
Nominal pressure (Chamber)	0.09 MPa	1.6 MPa with process flange PN16 4.0 MPa with process flange PN40
Process connection	S... = welding stubs OD F.../.../... = flanges acc. to DIN or ANSI GM.. = threaded stubs, female GN.. = threaded stubs, male	
Distance centre-to-centre	M	= 80 mm ... 1000 mm
Electrical connection	Terminal box	Aluminium 64 x 58 x 34 mm, with 1 contact Aluminium 80 x 75 x 57 mm, 2 or more contacts
Guide tube - OD	12 mm or 14 mm	
Float	V44A	V52A
Limit S.G. 85%	see KSR Floats page 30/31	
Limit S.G. 50%		
Temperature range standard	-30°C ... +150°C	
High temperature (HT..)	+150°C...+300°C see page 34	
Switch function	optional closing S , opening O or change-over SPDT U - on rising level	
Number of contacts	6 x S or O or 4 x U depending on distance centre-to-centre M....	
Switch rating	closing 230V AC; 100VA; 1A 230V DC; 50W; 0.5A opening 230V AC; 100VA; 1A 230V DC; 50W; 0.5A change-over 230V AC; 40VA; 1A 230V DC; 20W; 0.5A	
Orientation	vertical ± 30°	
Ingress protection	IP 65	

1003-4

Options process connection

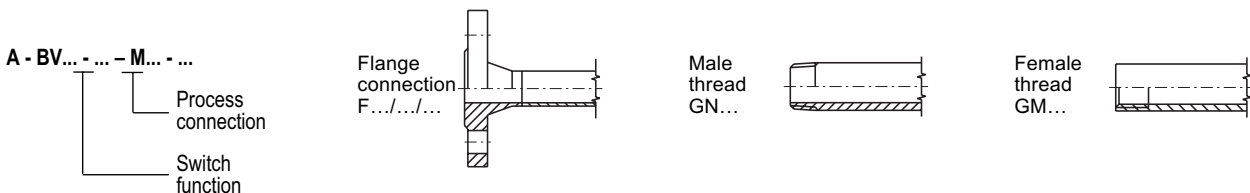

Spherical floats

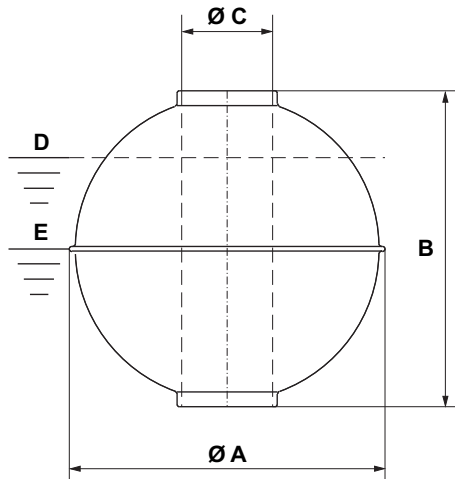

D = Limit S.G.
at 85% immersed float

E = Nominal S.G.
at 50% immersed float

Material	Type * Code 6	A mm	B mm	C mm	Max.operating pressure MPa	Max.operating temperature °C	Weight g	Volume cm ³	Limit S.G. (D) 85% kg/m ³	Nominal S.G. (E) 50% kg/m ³
Stainless steel SS 316 Ti (1.4571)	V29A/0.15	29	28	9	0.6	100	7	8	977	1660
	V29A/0.2	29	28	9	2.5	100	8	8	1069	1817
	V52A (SV)	52	52	15	4.0	300	37	57	769	1307
	V62A (SVA)	62	61	15	3.2	300	52	102	597	1015
	V83A (SVB)	83	81	15	2.5	300	88	254	408	693
	V80A (SVB23)	80	76	23	2.5	300	115	198	679	1155
	V98A (SVC)	98	96	23	2.5	300	215	423	597	1016
	V105A (SVD)	105	103	23	2.5	300	240	529	533	907
	V120A (SVF23)	120	117	23	2.5	300	268	811	389	661
Titanium Grade 2 (3.7035)	T29A	29	28	9	3.0	100	6	8	822	1397
	T52A (STi)	52	52	15	2.5	300	34	57	707	1201
	T52A/0,6	52	52	15	6.0	300	41	57	852	1448
	T52A/0,8	52	52	15	8.0	300	51	57	1060	1802
	T62A (STA)	62	62	15	2.5	300	44	102	505	859
	T83A (STB)	83	81	15	2.5	300	60	254	278	473
	T80A (STB23)	80	76	23	2.5	300	112	198	665	1130
	T98A (STC)	98	96	23	2.5	300	178	423	495	841
	T105A (STD)	105	103	23	2.5	300	166	529	369	627
T120A	120	117	23	2.5	300	227	811	329	560	
Stainless steel SS 316 Ti (1.4571) ECTFE-coated	VEC53A	53	53	14	2.5	dep. on liquid	39	62	745	1266
	VEC63A	63	62	14	2.5	dep. on liquid	55	109	591	1005
	VEC84A	84	82	14	2.5	dep. on liquid	91	266	403	685
	VEC81A	81	77	22	2.5	dep. on liquid	128	210	718	1220
	VEC99A	99	97	22	2.5	dep. on liquid	245	427	675	1148
	VEC106A	106	104	22	2.5	dep. on liquid	278	517	633	1076
	VEC121A	121	118	22	2.5	dep. on liquid	310	794	459	781

Type code in brackets for design Ex-0

Cylindrical floats

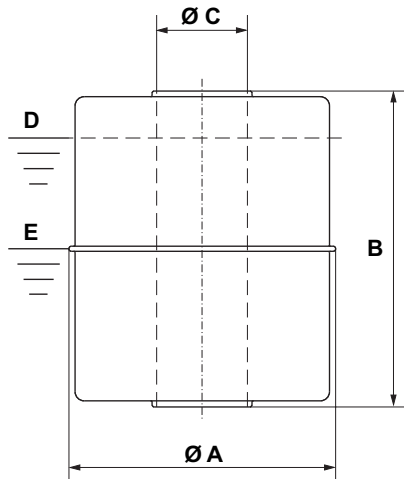

D = Limit S.G.
at 85% immersed float

E = Nominal S.G.
at 50% immersed float

Material	Type * Code 6	A mm	B mm	C mm	Max. operating pressure MPa	Max. operating temperature °C	Weight g	Volume cm ³	Limit S.G. (D) 85% kg/m ³	Nominal S.G. (E) 50% kg/m ³
Stainless steel SS 316 Ti (1.4571)	V27A	27	31	10	1.6	100	8	12	787	1338
	V44A (SVK)	44	52	15	1.6	300	42	60	818	1390
Titanium Grade 2 (3.7035)	T44A (STK)	44	52	15	1.6	300	37	60	720	1224
Buna	B20A	20	20	9	0.3	80	4	5	939	1597
	B23A	23	25	9	0.3	80	6	9	802	1364
	B25A	25	14	9	0.3	80	4	6	787	1337
	B30A	30	45	13	0.3	80	15	26	683	1161
	B40A	40	30	15	0.3	80	16	32	581	988
	B40A/120	40	120	15	0.3	80	45	130	409	694
	B50A	50	45	19	0.3	80	32	76	498	847
PVC	P44A	44	44	14	0.3	60	30	54	651	1107
	P55A	55	54	22	0.3	60	70	103	798	1357
	P55A/26	55	80	26	0.3	60	110	141	919	1563
	P55A/70	55	70	22	0.3	60	80	140	674	1145
	P80A	80	79	25	0.3	60	165	339	573	974
Polypropylene	PP27A	27	29	9	0.3	80	9	14	755	1284
	PP35A	35	33	9	0.3	80	15	26	675	1148
	PP44A	44	44	14	0.3	80	22	54	478	812
	PP55A	55	54	22	0.3	80	51	103	582	989
	PP55A/26	55	80	26	0.3	80	80	141	669	1137
	PP80A	80	79	25	0.3	80	124	339	431	732
PVDF	PF44A	44	55	14	0.3	100	45	68	782	1329
	PF55A	55	69	22	0.3	100	92	132	821	1396
	PF55A/26	55	80	26	0.3	100	143	148	1140	1938
	PF80A	80	79	25	0.3	100	196	339	681	1157
Stainless steel SS 316 Ti (1.4571) ECTFE-coated	VEC45A	45	53	14	1.6	dep. on liquid	44	66	782	1329

Type code in brackets for design Ex-0

Connection diagrams Colour coding to IEC 757

PVC cable max. temperature 90°C		Silicone cable max. temperature 150°C		Terminal box max. temperature 260°C	
opening or closing	change-over	opening or closing	change-over	opening or closing	change-over
1 switchpoint BU L1 BN L1	1 switchpoint BU L1 BN L1 BK L1	1 switchpoint BU L1 BN L1	1 switchpoint BU L1 BN L1 BK L1	1 switchpoint BU L1 BN L1	1 switchpoint BU L1 BN L1 BK L1
2 switchpoints BK L1 BK L1 BN L2 BU L2	2 switchpoints YE L1 GN L1 BN L1 BU L2 PK L2 GY L2	2 switchpoints BK L1 BK L1 BN L2 BU L2	2 switchpoints YE L1 GN L1 BN L1 BU L2 RD L2 WH L2	2 switchpoints BK L1 BK L1 BN L2 BU L2	2 switchpoints YE L1 GN L1 BN L1 BU L2 RD L2 WH L2
3 switchpoints GN L1 BN L1 YE L2 GY L2 PK L3 BU L3	3 switchpoints BU/RD L1 RD L1 WH L1 YE L2 GN L2 BN L2 BU L3 PK L3 GY L3	3 switchpoints BN L1 WH L1 YE L2 GN L2 BU L3 RD L3		3 switchpoints BN L1 WH L1 YE L2 GN L2 BU L3 RD L3	
4 switchpoints RD L1 WH L1 GN L2 BN L2 YE L3 GY L3 PK L4 BU L4	4 switchpoints BU/RD L1 RD L1 WH L1 YE L2 GN L2 BN L2 BU L3 PK L3 GY L3			4 switchpoints RD L1 WH L1 GN L2 BN L2 YE L3 GY L3 PK L4 BU L4	3 switchpoints WH L1 BK L1 OG L1 YE L2 GN L2 BN L2 BU L3 PK L3 GY L3
5 switchpoints BK L1 VT L1 RD L2 WH L2 GN L3 BN L3 YE L4 GY L4 PK L5 BU L5	4 switchpoints GY/RD L1 BK L1 VT L1 BU/RD L2 RD L2 WH L2 YE L3 GN L3 BN L3 BU L4 PK L4 GY L4			5 switchpoints RD L1 WH L1 GN L2 BN L2 YE L3 GY L3 PK L4 BU L4 VT L5 CLEAR L5	4 switchpoints WH L1 BK L1 OG L1 YE L2 GN L2 BN L2 BU L3 PK L3 GY L3 RD L4 VT L4 CLEAR L4
6 switchpoints GY/RD L1 BU/RD L1 BK L2 VT L2 RD L3 WH L3 GN L4 BN L4 YE L5 GY L5 PK L6 BU L6				6 switchpoints RD L1 WH L1 GN L2 BN L2 YE L3 GY L3 PK L4 BU L4 VT L5 CLEAR L5 BK L6 OG L6	

1003-4

Connection diagrams Colour coding to IEC 757

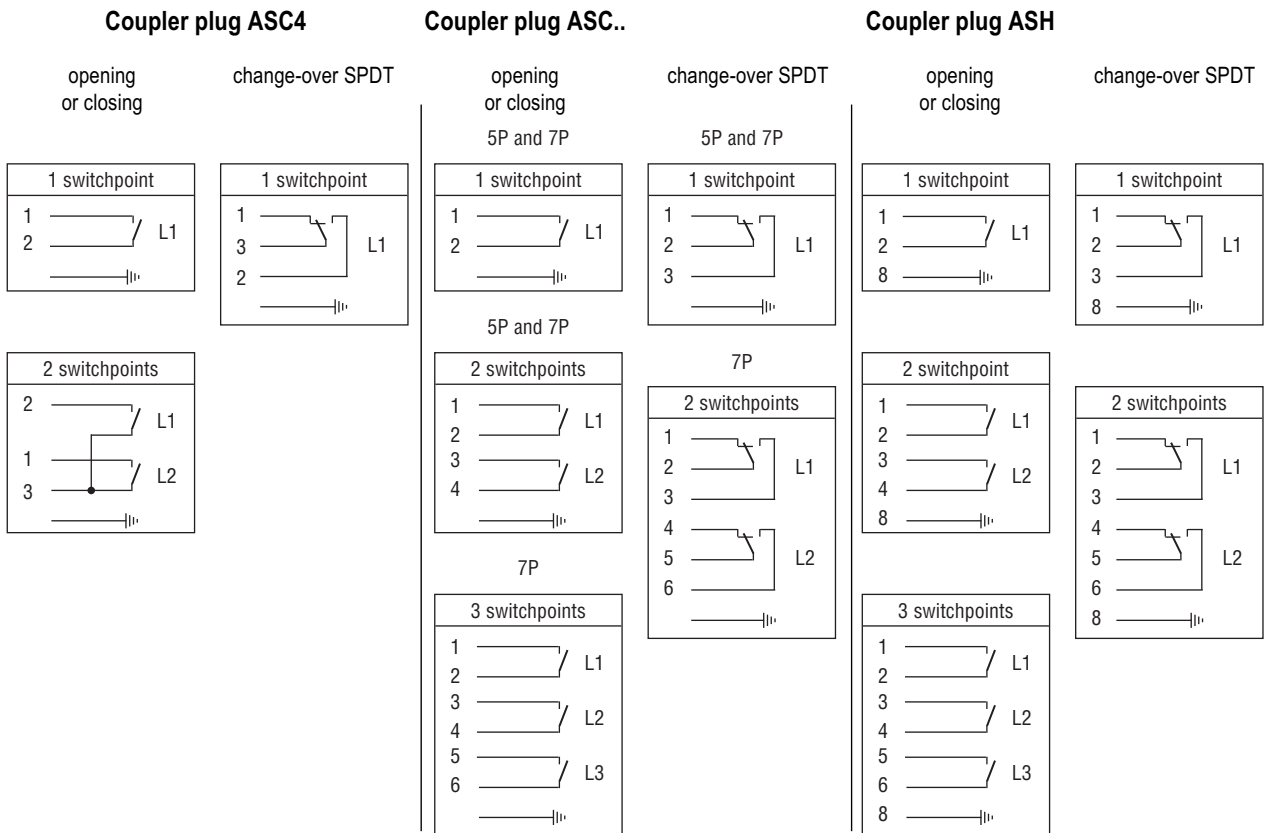

KSR Magnetic Float Switches with temperature switches

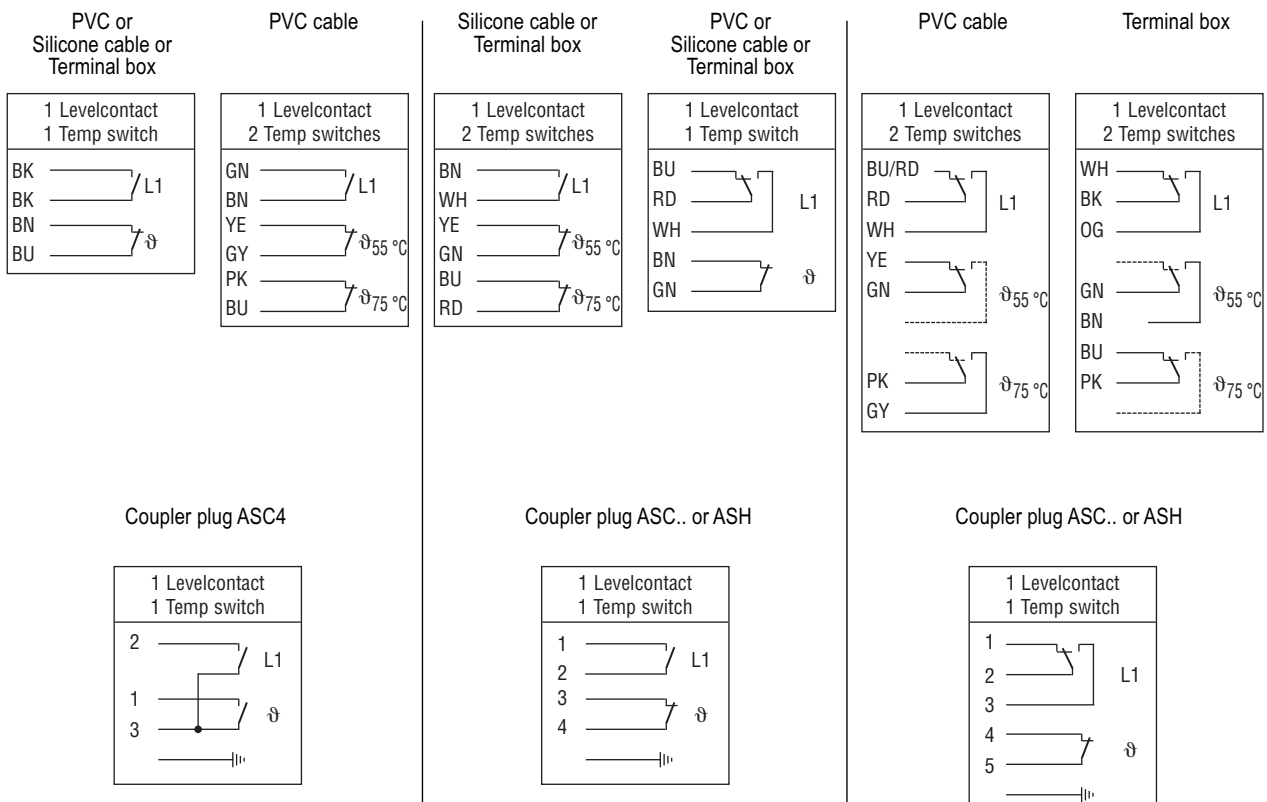

KSR Magnetic Float Switches



Contact protection measures

To ensure reliable operation and highest possible service life, we recommend using one of the following circuits.

Inductive load AC

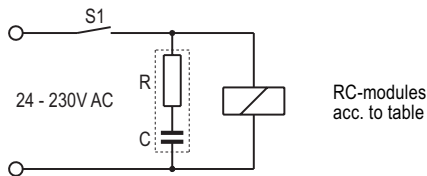

Inductive load DC

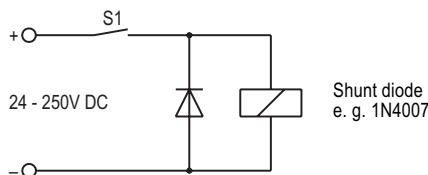

Current limitation with capacitive load e.g. PLC and cables >50m

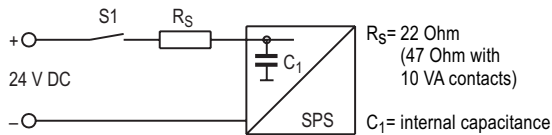

Current limitation with electronic timers

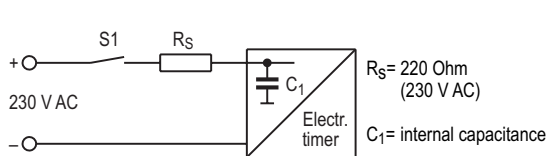

Current measurement with oscilloscope

Example:
C = 0.33µF/24V DC

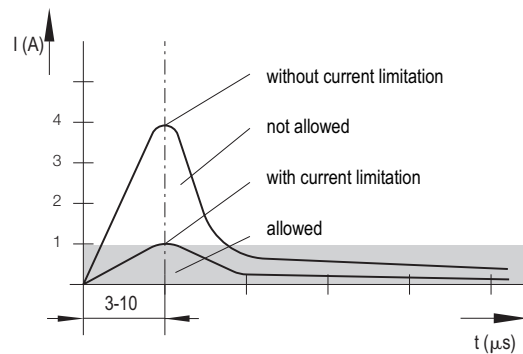
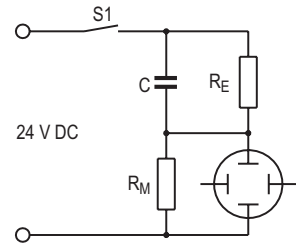

Protective RC-modules

Please use RC-modules according to the table below. Rating of the switches and supply voltage will determine the type to be used.

For reed contacts 10-40VA

Capacitance	Resistance	Voltage	Type
0.33 µF	100 Ohm	24V AC	A 3/24
0.33 µF	220 Ohm	48V AC	A 3/48
0.33 µF	470 Ohm	115V AC	A 3/115
0.33 µF	1500 Ohm	230V AC	A 3/230

For reed contacts 40-100VA

Capacitance	Resistance	Voltage	Type
0.33 µF	47 Ohm	24V AC	B 3/24
0.33 µF	100 Ohm	48V AC	B 3/48
0.33 µF	470 Ohm	115V AC	B 3/115
0.33 µF	1000 Ohm	230V AC	B 3/230

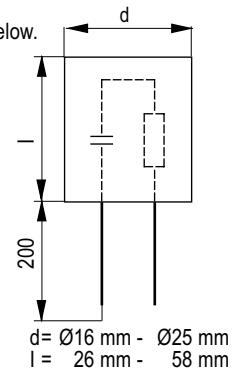

Others types might lead to destruction or lower service life of the reed contacts.

Remarks for high and low temperature design

Contact function
max. number of contacts
Switching capacity

optional closing (S) or opening (O) on rising level
2, 1 float per contact, distance L1 - L2 according float size
closing or opening 48V AC; 20VA; 0.4A 48V DC; 10W; 0.2A



KSR-KUEBLER Niveau-Messtechnik AG

69439 Zwingenberg
Germany
Tel ++ 49 (0) 62 63-87- 0
Fax ++ 49 (0) 62 63-87 99

www.ksr-kuebler.com
info@ksr-kuebler.com